



PROFESSIONAL DIGITAL TWO-WAY RADIO

**MOTOTRBO™**  
**DGP™ 8050 EX**  
**NON-DISPLAY PORTABLE**  
**USER GUIDE**



## Declaration of Conformity

### DECLARATION OF CONFORMITY

Per FCC CFR 47 Part 2 Section 2.1077(a)



Responsible Party

Name: Motorola Solutions, Inc.

Address: 1303 East Algonquin Road, Schaumburg, IL 60196-1078, U.S.A.

Phone Number: 1-800-927-2744

Hereby declares that the product:

Model Name: **DGP8050 Ex**

conforms to the following regulations:

FCC Part 15, subpart B, section 15.107(a), 15.107(d) and section 15.109(a)

#### **Class B Digital Device**

As a personal computer peripheral, this device complies with Part 15 of the FCC Rules. Operation is subject to the following two conditions:

1. This device may not cause harmful interference, and
2. This device must accept any interference received, including interference that may cause undesired operation.

**Note:** This equipment has been tested and found to comply with the limits for a Class B digital device, pursuant to part 15 of the FCC Rules. These limits are designed to provide reasonable protection against harmful interference in a residential installation. This equipment generates, uses and can radiate radio frequency energy and, if not installed and used in accordance with the instructions, may cause harmful interference to radio communications. However, there is no guarantee that interference will not occur in a particular installation.

If this equipment does cause harmful interference to radio or television reception, which can be determined by turning the equipment off and on, the user is encouraged to try to correct the interference by one or more of the following measures:

- Reorient or relocate the receiving antenna.
- Increase the separation between the equipment and receiver.
- Connect the equipment into an outlet on a circuit different from that to which the receiver is connected.
- Consult the dealer or an experienced radio/TV technician for help.

**Contents**

This User Guide contains all the information you need to use the MOTOTRBO DGP Series Digital Portable Radios.

**Declaration of Conformity** . . . . . **i**

**Important Safety Information** . . . . . **iv**  
     Product Safety and RF Exposure Compliance . . .iv

**Software Version** . . . . . **iv**

**Computer Software Copyrights** . . . . . **v**

**Handling Precautions** . . . . . **vi**

**Notes** . . . . . **viii**

**Getting Started** . . . . . **1**  
     How to Use This Guide . . . . . 1  
     What Your Dealer/System Administrator  
     Can Tell You . . . . . 1

**Preparing Your Radio for Use** . . . . . **2**  
     Charging the Battery . . . . . 2  
     Attaching the Battery . . . . . 3  
     Attaching the Antenna . . . . . 3  
     Attaching the Belt Clip . . . . . 4

    Attaching the Universal Connector Cover  
     (Dust Cover) . . . . . 4

    Powering Up the Radio . . . . . 5

    Adjusting the Volume . . . . . 5

**Identifying Radio Controls** . . . . . **6**  
     Radio Controls . . . . . 6  
     Programmable Buttons . . . . . 7  
         Assignable Radio Functions . . . . . 7  
         Assignable Settings or Utility Functions . . . . . 8  
     Push-To-Talk (PTT) Button . . . . . 8  
     Switching Between Conventional Analog and  
     Digital Mode . . . . . 9  
     IP Site Connect . . . . . 10  
     Capacity Plus . . . . . 10  
     Linked Capacity Plus . . . . . 11

**Identifying Status Indicators** . . . . . **12**  
     LED Indicator . . . . . 12  
     Indicator Tones . . . . . 13  
     Audio Tones . . . . . 13

**Receiving and Making Calls** . . . . . **14**  
     Selecting a Zone . . . . . 14  
     Selecting a Channel . . . . . 14  
     Receiving and Responding to a Radio Call . . . . . 15  
         Receiving and Responding to a Group Call . . . . . 15

Receiving and Responding to a Private Call . . .	16	Vote Scan . . . . .	26
Receiving and Responding to a Selective Call . .	16	Call Indicator Settings . . . . .	27
Receiving an All Call . . . . .	17	Escalating Alarm Tone Volume . . . . .	27
Receiving and Responding to a Phone Call . . .	17	Call Alert Operation . . . . .	27
Phone Call as a Private Call or Group Call . . .	17	Receiving and Responding to a Call Alert . . . . .	27
Phone Call as an All Call . . . . .	18	Making a Call Alert with the One Touch Access Button . . . . .	27
Making a Radio Call . . . . .	18	Emergency Operation . . . . .	28
Making a Call with the Channel Selector Knob . .	19	Sending an Emergency Alarm . . . . .	29
Making a Group Call . . . . .	19	Sending an Emergency Alarm with Call . . . . .	29
Making a Private Call . . . . .	19	Sending an Emergency Alarm with Voice to Follow . . . . .	30
Making a Selective Call . . . . .	20	Reinitiating an Emergency Mode . . . . .	31
Making an All Call . . . . .	21	Exiting an Emergency Mode . . . . .	32
Making a Phone Call . . . . .	21	Text Messaging Features . . . . .	32
Stopping a Radio Call . . . . .	22	Sending a Quick Text Message . . . . .	32
Talkaround . . . . .	22	Privacy . . . . .	33
Monitoring Features . . . . .	23	Multi-Site Controls . . . . .	34
Monitoring a Channel . . . . .	23	Starting an Automatic Site Search . . . . .	34
Permanent Monitor . . . . .	23	Stopping an Automatic Site Search . . . . .	34
<b>Advanced Features . . . . .</b>	<b>24</b>	Starting a Manual Site Search . . . . .	34
Scan Lists . . . . .	24	Lone Worker . . . . .	35
Scan . . . . .	25	Password Lock Features . . . . .	35
Starting and Stopping Scan . . . . .	25	Accessing the Radio from Password . . . . .	35
Responding to a Transmission During a Scan . .	25	Unlocking the Radio from Locked State . . . . .	36
Deleting a Nuisance Channel . . . . .	26		
Restoring a Nuisance Channel . . . . .	26		

Auto-Range Transponder System (ARTS) . . . . . 36

Over-the-Air Programming (OTAP) . . . . . 37

Utilities . . . . . 37

    Setting the Squelch Level . . . . . 37

    Setting the Power Level . . . . . 37

    Turning the Voice Operating Transmission  
 (VOX) Feature On or Off . . . . . 38

    Turning Radio Tones/Alerts On or Off . . . . . 38

    Checking the Battery Strength . . . . . 39

    Voice Announcement . . . . . 39

    Intelligent Audio . . . . . 39

    GPS . . . . . 39

**Accessories . . . . . 40**

    Antennas . . . . . 40

    Batteries . . . . . 40

    Carry Devices . . . . . 40

    Chargers . . . . . 40

    Headsets and Headset Accessories . . . . . 41

    Remote Speaker Microphones . . . . . 41

    Miscellaneous Accessories . . . . . 41

**Batteries and Chargers Warranty . . . . . 42**

**Limited Warranty . . . . . 43**

## Important Safety Information

### Product Safety and RF Exposure Compliance



Caution

Before using this product, read the operating instructions for safe usage contained in the Product Safety and RF Exposure booklet enclosed with your radio.

### ATTENTION!

**This radio is restricted to occupational use only to satisfy FCC RF energy exposure requirements.**

Before using this product, read the RF energy awareness information and operating instructions in the Regulatory Compliance and Product Safety section of your Quick Reference Guide enclosed with your radio (Motorola Publication part number 68009586001) to ensure compliance with RF energy exposure limits.

Keep the Quick Reference Guide available to all users of the radio.

For a list of Motorola-approved antennas, batteries, and other accessories, visit the following website:

<http://www.motorolasolutions.com>

*Any modification to this device, not expressly authorized by Motorola, may void the safety and regulatory compliance of the radio. The radio must only be repaired or serviced at authorized Motorola Service Centers. Contact your dealer or system administrator for details.*

### Software Version

All the features described in the following sections are supported by the radio's software version **R02.05.00**.

Please check with your dealer or system administrator for more details of all the features supported.



## Computer Software Copyrights

The Motorola products described in this manual may include copyrighted Motorola computer programs stored in semiconductor memories or other media. Laws in the United States and other countries preserve for Motorola certain exclusive rights for copyrighted computer programs including, but not limited to, the exclusive right to copy or reproduce in any form the copyrighted computer program. Accordingly, any copyrighted Motorola computer programs contained in the Motorola products described in this manual may not be copied, reproduced, modified, reverse-engineered, or distributed in any manner without the express written permission of Motorola. Furthermore, the purchase of Motorola products shall not be deemed to grant either directly or by implication, estoppel, or otherwise, any license under the copyrights, patents or patent applications of Motorola, except for the normal non-exclusive license to use that arises by operation of law in the sale of a product.

The AMBE+2™ voice coding Technology embodied in this product is protected by intellectual property rights including patent rights, copyrights and trade secrets of Digital Voice Systems, Inc.

This voice coding Technology is licensed solely for use within this Communications Equipment. The user of this Technology is explicitly prohibited from attempting to decompile, reverse engineer, or disassemble the Object Code, or in any other way convert the Object Code into a human-readable form.

U.S. Pat. Nos. #5,870,405, #5,826,222, #5,754,974, #5,701,390, #5,715,365, #5,649,050, #5,630,011, #5,581,656, #5,517,511, #5,491,772, #5,247,579, #5,226,084 and #5,195,166.

## Handling Precautions

The MOTOTRBO Series Digital Portable radio meets IP67 specifications, allowing the radio to withstand adverse field conditions such as being submersed in water.

- If the radio has been submersed in water, shake the radio well to remove any water that may be trapped inside the speaker grille and microphone port. Trapped water could cause decreased audio performance.
- If the radio's battery contact area has been exposed to water, clean and dry battery contacts on both the radio and the battery before attaching the battery to the radio. The residual water could short-circuit the radio.
- If the radio has been submersed in a corrosive substance (e.g. saltwater), rinse the radio and battery in fresh water then dry the radio and battery.
- To clean the exterior surfaces of the radio, use a diluted solution of mild dishwashing detergent and fresh water (i.e. one teaspoon of detergent to one gallon of water).

- Never poke the vent (hole) located on the radio chassis below the battery contact. This vent allows for pressure equalization in the radio. Doing so may create a leak path into the radio and the radio's submersibility may be lost.
- Never obstruct or cover the vent, even with a label.
- Ensure that no oily substances come in contact with the vent.
- The radio with antenna attached properly is designed to be submersible to a maximum depth of 1 meter (3.28 feet) and a maximum submersion time of 30 minutes. Exceeding either maximum limit or use without antenna may result in damage to the radio.
- When cleaning the radio, do not use a high pressure jet spray on the radio as this will exceed the 1 meter depth pressure and may cause water to leak into the radio.



**Caution**

Do not disassemble the radio. This could damage radio seals and result in leak paths into the radio. Radio maintenance should only be done in service depot that is equipped to test and replace the seal on the radio.

## Getting Started

Take a moment to review the following:

How to Use This Guide . . . . .	page 1
What Your Dealer/System Administrator Can Tell You . . . . .	page 1

### ■ How to Use This Guide

This User Guide covers the basic operation of the MOTOTRBO Non-Display Portables.

However, your dealer or system administrator may have customized your radio for your specific needs. Check with your dealer or system administrator for more information.

Throughout this publication, the icons below are used to indicate features supported in either the conventional Analog mode or conventional Digital mode:



Indicates a conventional **Analog Mode-Only** feature.



Indicates a conventional **Digital Mode-Only** feature.

For features that are available in **both** Analog and Digital modes, **no** icon is shown.

For features that are available in a conventional multi-site mode, see **IP Site Connect** on page 10 for more information. Selected features are **also** available on the single-site trunking mode, Capacity Plus. See **Capacity Plus** on page 10 for more information.

Selected features are **also** available in the multi-site trunking mode, Linked Capacity Plus. See **Linked Capacity Plus** on page 11 for more information.

### ■ What Your Dealer/System Administrator Can Tell You

You can consult your dealer or system administrator about the following:

- Is your radio programmed with any preset conventional channels?
- Which buttons have been programmed to access other features?
- What optional accessories may suit your needs?
- What are the best radio usage practices for effective communication?
- What maintenance procedures will help promote longer radio life?

## Preparing Your Radio for Use

Assemble your radio by following these steps:

- Charging the Battery . . . . . page 2
- Attaching the Battery . . . . . page 3
- Attaching the Antenna . . . . . page 3
- Attaching the Belt Clip . . . . . page 4
- Attaching the Universal Connector Cover (Dust Cover) . . . . . page 4
- Powering Up the Radio . . . . . page 5
- Adjusting the Volume . . . . . page 5

## Charging the Battery



Caution

Charge your battery only in non-hazardous areas. After battery is charged, allow your radio to rest for at least 3 minutes. See **Batteries** on page 40 for available batteries.

For best performance, your radio is powered by a Motorola-approved Lithium-Ion (Li-Ion) battery. To avoid damage and comply with warranty terms, charge the battery using a Motorola charger *exactly* as described in the charger user guide.

If battery is attached to your radio, ensure that your radio remains powered off while charging.

Charge a new battery 14 to 16 hours before initial use for best performance.

**IMPORTANT:** **ALWAYS** charge your IMPRES battery with an IMPRES charger for optimized battery life and valuable battery data. IMPRES batteries charged exclusively with IMPRES chargers receive a 6-month capacity warranty extension over the standard Motorola Premium battery warranty duration.

## ■ Attaching the Battery



**Caution**

Do not replace battery in gas and dust environments. Replace battery only in non-hazardous areas. See **Batteries** on page 40 for available batteries.

Align the battery with the rails on the back of the radio. Press the battery firmly, and slide upward until the latch snaps into place. Slide battery latch into lock position.

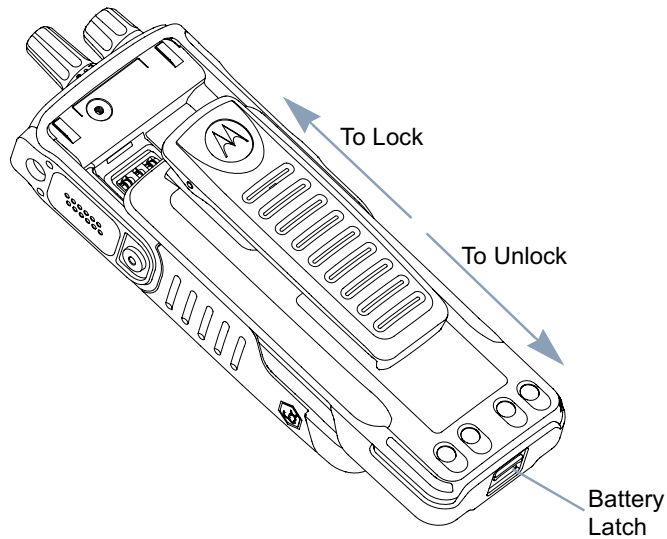

*To remove the battery, turn the radio off. Move the battery latch into unlock position and hold, and slide the battery down and off the rails.*

## ■ Attaching the Antenna

With the radio turned off, set the antenna in its receptacle and turn clockwise.

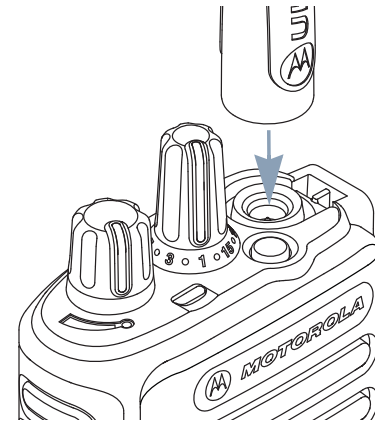

*To remove the antenna, turn the antenna counterclockwise.*



**Caution**

If antenna needs to be replaced, ensure that only MOTOTRBO antennas are used. Neglecting this will damage your radio. See **Antennas** on page 40 for a list of available antennas.

## ■ Attaching the Belt Clip

Align the grooves on the clip with those on the battery and press downward until you hear a click.

*To remove the clip, press the belt clip tab away from the battery using a key. Then slide the clip upward and away from the radio.*

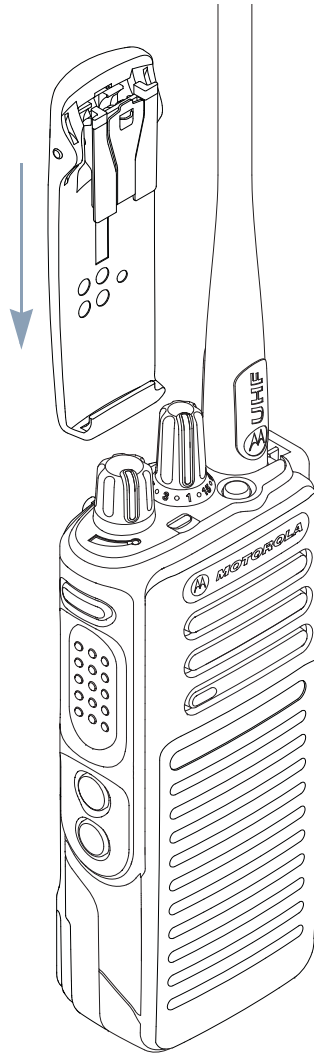

## ■ Attaching the Universal Connector Cover (Dust Cover)

The universal connector is located on the antenna side of the radio. It is used to connect MOTOTRBO accessories to the radio.

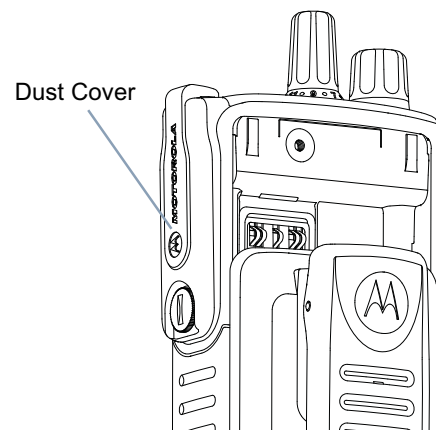

Insert the hooked end of the cover into the slots above the universal connector. Press downward on the cover to seat the lower tab properly into the RF connector.

Turn the thumbscrew clockwise to secure the connector cover to the radio.

*To remove the universal connector cover, press down on the cover and turn the thumbscrew counterclockwise.*

*Replace the dust cover when the universal connector is not in use.*

## ■ Powering Up the Radio

Rotate the **On/Off/Volume Control Knob** clockwise until you hear a click. The LED lights up solid green.

A brief tone sounds, indicating that the power up test is successful.

**NOTE:** There is no power up tone if the radio tones/alerts function is disabled (see **Turning Radio Tones/Alerts On or Off** on page 38).

If your radio does not power up, check your battery. Make sure that it is charged and properly attached. If your radio still does not power up, contact your dealer.

*To turn off the radio, rotate this knob counterclockwise until you hear a click.*

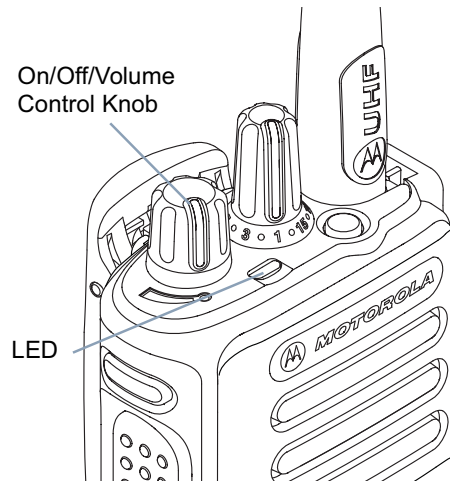

## ■ Adjusting the Volume

To increase the volume, turn the **On/Off/Volume Control Knob** clockwise.

*To decrease the volume, turn this knob counterclockwise.*

**NOTE:** Your radio can be programmed to have a minimum volume offset where the volume level cannot be turned past the programmed minimum volume. Check with your dealer or system administrator for more information.

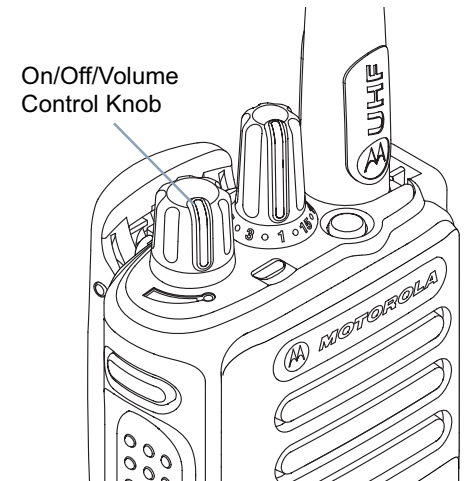

# Identifying Radio Controls

Take a moment to review the following:

- Radio Controls . . . . . page 6
- Programmable Buttons . . . . . page 7
- Push-To-Talk (PTT) Button . . . . . page 8
- Switching Between Conventional Analog and Digital Mode. . . . . page 9
- IP Site Connect . . . . . page 10
- Capacity Plus . . . . . page 10
- Linked Capacity Plus. . . . . page 11

## Radio Controls

- 1 Channel Selector Knob
- 2 On/Off/Volume Control Knob
- 3 LED Indicator
- 4 Side Button 1\*
- 5 Push-to-Talk (PTT) Button
- 6 Side Button 2\*
- 7 Side Button 3\*
- 8 Microphone

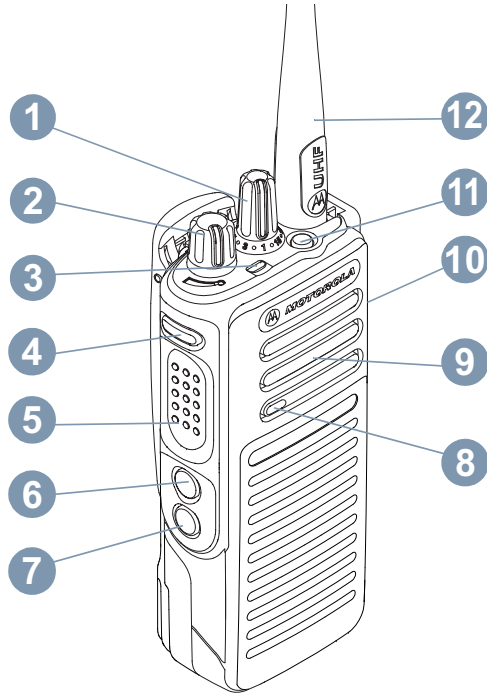

- 9 Speaker
- 10 Universal Connector for Accessories
- 11 Emergency Button\*
- 12 Antenna

\* These buttons are programmable.



## ■ Programmable Buttons

Your dealer can program the programmable buttons as shortcuts to **radio functions** or **preset channels/groups** depending on the duration of a button press:

- Short press – Pressing and releasing rapidly.
- Long press – Pressing and holding for the programmed duration.
- Hold down – Keeping the button pressed.

**NOTE:** The programmed duration of a button press is applicable for all assignable radio/utility functions or settings. See **Emergency Operation** on page 28 for more information on the programmed duration of the **Emergency** button.

### Assignable Radio Functions

**Call Forwarding** – Toggles Call Forwarding on or off.

**Voice Announcement for Channel** – Plays zone and channel announcement voice messages for the current channel. This function is unavailable when Voice Announcement is disabled.

**Emergency** – Depending on the programming, initiates or cancels an emergency alarm or call.

**Intelligent Audio On/Off** – Toggles Intelligent Audio on or off.

**Manual Site Roam\*\***  – Starts the manual site search.

**Mic AGC On/Off** – Toggles the internal microphone automatic gain control (AGC) on or off.

**Monitor** – Monitors a selected channel for activity.

**Nuisance Channel Delete\*\*** – Temporarily removes an unwanted channel, except for the Selected Channel, from the scan list. The Selected Channel refers to the user's selected zone/channel combination from which scan is initiated.

**Notifications** – Provides direct access to the Notifications List.

**One Touch Access**  – Directly initiates a predefined Private, Phone or Group Call, a Call Alert or a Quick Text message.

**Option Board Feature** – Toggles option board feature(s) on or off for option board-enabled channels.

**Permanent Monitor\*\*** – Monitors a selected channel for all radio traffic until function is disabled.

**Privacy**  – Toggles privacy on or off.

**Phone Exit**  – Ends the current Phone Call.

\* Not applicable in Capacity Plus

‡ Not applicable in Linked Capacity Plus

**Repeater/Talkaround\*‡** – Toggles between using a repeater and communicating directly with another radio.

**Scan\*‡** – Toggles scan on or off.

**Site Info\*** – Plays site announcement voice messages for the current site (this function is unavailable when Voice Announcement is disabled).

**Site Lock On/Off\***  – Toggles the automatic site roam on or off.

**Telemetry Control**  – Controls the Output Pin on a local or remote radio.

**Transmit Interrupt Remote Dekey**  – Stops an ongoing interruptible call to free the channel.

**Voice Announcement On/Off** – Toggles Voice Announcement on or off.

**Voice Operating Transmission (VOX)** – Toggles VOX on or off.

**Zone** – Allows selection from a list of zones.

**Battery Strength** – Indicates battery strength via the LED Indicator.

\* Not applicable in Capacity Plus

‡ Not applicable in Linked Capacity Plus

## Assignable Settings or Utility Functions

**All Tones/Alerts** – Toggles all tones and alerts on or off.

**Power Level** – Toggles transmit power level between high and low.

**Squelch**  – Toggles squelch level between tight and normal.

## ■ Push-To-Talk (PTT) Button

The **PTT** button on the side of the radio serves two basic purposes:

- While a call is in progress, the **PTT** button allows the radio to transmit to other radios in the call.

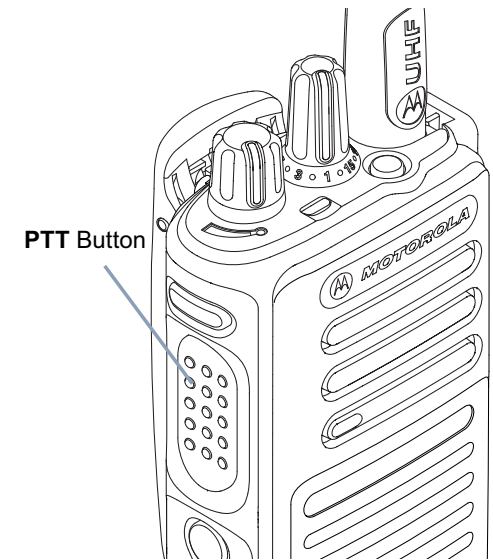

Press and hold down **PTT** button to talk.  
Release the **PTT** button to listen.

The microphone is activated when the **PTT** button is pressed.



- While a call is not in progress, the **PTT** button is used to make a new call (see **Making a Radio Call** on page 18).

Depending on programming, if the Talk Permit Tone or the **PTT** Sidetone  is enabled, wait until the short alert tone ends before talking.

-  During a call, if the Channel Free Indication feature is enabled on your radio (programmed by your dealer), you hear a short alert tone the moment the target radio (the radio that is receiving your call) releases the **PTT** button, indicating the channel is free for you to respond.
-  You will also hear a continuous talk prohibit tone, if your call is interrupted, indicating that you should release the **PTT** button, for example when the radio receives an Emergency Call.

## ■ Switching Between Conventional Analog and Digital Mode

Each channel in your radio can be configured as a conventional analog or conventional digital channel. Use the Channel Selector Knob to switch between an analog or a digital channel.

When switching from digital to analog mode, certain features are unavailable.

Your radio also has features available in both analog and digital mode. However, the minor differences in the way each feature works does **NOT** affect the performance of your radio.

**NOTE:** Your radio also switches between digital and analog modes during a dual mode scan (see **Scan** on page 25).

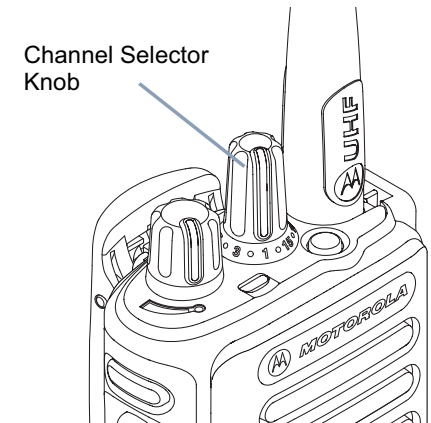

## ■ IP Site Connect

---

This feature allows your radio to extend conventional communication beyond the reach of a single site, by connecting to different available sites which are connected via an Internet Protocol (IP) network.

When the radio moves out of range from one site and into the range of another, it connects to the new site's repeater to send or receive calls/data transmissions. Depending on your settings, this is done automatically or manually.

If the radio is set to do this automatically, it scans through all available sites when the signal from the current site is weak or when the radio is unable to detect any signal from the current site. It then locks on to the repeater with the strongest Received Signal Strength Indicator (RSSI) value.

In a manual site search, the radio searches for the next site in the roam list that is currently in range (but which may not have the strongest signal) and locks on to it.

**NOTE:** Each channel can only have either Scan or Roam enabled, not both at the same time.

Channels with this feature enabled can be added to a particular roam list. The radio searches the channel(s) in the roam list during the automatic roam operation to locate the best site.

A roam list supports a maximum of 16 channels (including the Selected Channel).

You cannot manually add or delete an entry to the roam list. Check with your dealer or system administrator for more information.

## ■ Capacity Plus

---

Capacity Plus is a single-site trunking configuration of the MOTOTRBO radio system, which uses a pool of channels to support hundreds of users and up to 254 Groups. This feature allows your radio to efficiently utilize the available number of programmed channels while in Repeater Mode.

Icons of features not applicable to Capacity Plus are not available in the menu. You hear a negative indicator tone if you try to access a feature not applicable to Capacity Plus via a programmable button press.

Your radio also has features that are available in conventional digital mode, IP Site Connect, Capacity Plus and Linked Capacity Plus. However, the minor differences in the way each feature works does **NOT** affect the performance of your radio.

Check with your dealer or system administrator for more information on this configuration.

## ■ Linked Capacity Plus

---

Linked Capacity Plus is a multi-site multi-channel trunking configuration of the MOTOTRBO radio system, combining the best of both Capacity Plus and IP Site Connect configurations.

Linked Capacity Plus allows your radio to extend trunking communication beyond the reach of a single site, by connecting to different available sites which are connected via an Internet Protocol (IP) network. It also provides an increase in capacity by efficiently utilizing the combined available number of programmed channels supported by each of the available sites.

When the radio moves out of range from one site and into the range of another, it connects to the new site's repeater to send or receive calls/data transmissions. Depending on your settings, this is done automatically or manually.

If the radio is set to do this automatically, it scans through all available sites when the signal from the current site is weak or when the radio is unable to detect any signal from the current site. It then locks on to the repeater with the strongest Received Signal Strength Indicator (RSSI) value.

In a manual site search, the radio searches for the next site in the roam list that is currently in range (but which may not have the strongest signal) and locks on to it.

Any channel with Linked Capacity Plus enabled can be added to a particular roam list. The radio searches these channels during the automatic roam operation to locate the best site.

**NOTE:** You cannot manually add or delete an entry to the roam list. Check with your dealer or system administrator for more information.

Similar to Capacity Plus, icons of features not applicable to Linked Capacity Plus are not available in the menu. You hear a negative indicator tone if you try to access a feature not applicable to Linked Capacity Plus via a programmable button press.

Check with your dealer or system administrator for more information on this configuration.

## Identifying Status Indicators

Your radio indicates its operational status through the following:

LED Indicator . . . . .	page 12
Audio Tones . . . . .	page 13
Indicator Tones . . . . .	page 13

### ■ LED Indicator

The LED indicator shows the operational status of your radio.

**Blinking red** – Radio is transmitting at low battery condition, receiving an emergency transmission or has failed the self-test upon powering up, or has moved out of range if radio is configured with Auto-Range Transponder System.

**Solid green** – Radio is powering up, or transmitting. Also indicates full charge of the battery when **Battery Strength** button is pressed.

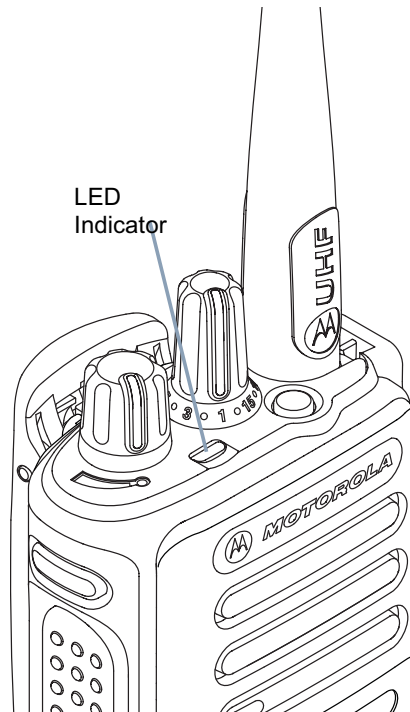

**Blinking green** – Radio is receiving a non-privacy-enabled call or data, or detecting activity or retrieving Over-the-Air Programming transmissions over the air.

**Double blinking green** – Radio is receiving a privacy-enabled call or data .

**Solid yellow** – Radio is monitoring a conventional channel. Also indicates fair battery charge when **Battery Strength** button is pressed.

**Blinking yellow** – Radio is scanning for activity or receiving a Call Alert, or all local Linked Capacity Plus channels are busy.

**Double blinking yellow** – Radio is no longer connected to the repeater while in Capacity Plus or Linked Capacity Plus, all Capacity Plus channels or Linked Capacity Plus channels are currently busy, Auto Roaming is enabled, radio is actively searching for a new site. Also indicates radio has yet to respond to a group call alert, or radio is locked.

**NOTE:** While in conventional mode, when the LED blinks green, it indicates the radio detects activity over the air. Due to the nature of the digital protocol, this activity may or may not affect the radio's programmed channel.

For Capacity Plus and Linked Capacity Plus, there is no LED indication when the radio is detecting activity over the air.

## ■ Indicator Tones

---

High pitched tone 

Low pitched tone 



Positive Indicator Tone





Negative Indicator Tone

## ■ Audio Tones

---

Alert tones provide you with audible indications of the radio's status or the radio's response to data received.

**Continuous Tone**  A monotone sound. Sounds continuously until termination.

**Periodic Tone**  Sounds periodically depending on the duration set by the radio. Tone starts, stops, and repeats itself.

**Repetitive Tone**  A single tone that repeats itself until it is terminated by the user.

**Momentary Tone**  Sounds only once for a short period of time defined by the radio.

## Receiving and Making Calls

Once you understand how your MOTOTRBO Portable is configured, you are ready to use your radio.

Use this navigation guide to familiarize yourself with the basic Call features:

- Selecting a Zone . . . . . page 14
- Selecting a Radio Channel, Subscriber ID, or Group ID . . . . . page 14
- Receiving and Responding to a Radio Call. . . . . page 15
- Making a Radio Call . . . . . page 18
- Stopping a Radio Call . . . . . page 22
- Talkaround . . . . . page 22
- Monitoring Features . . . . . page 23

### Selecting a Zone

A zone is a group of channels. Your radio supports up to 32 channels and 2 zones, with a maximum of 16 channels per zone.

**Procedure:**

- 1 Press the programmed **Zone** button.
- 
- 2 You hear a positive indicator tone, indicating the radio has switched from Zone 1 to Zone 2.
- OR**

You hear a negative indicator tone, indicating the radio has switched from Zone 2 to Zone 1.

---

### Selecting a Channel

Transmissions are sent and received on a channel. Depending on your radio's configuration, each channel may have been programmed differently to support different groups of users or supplied with different features. After selecting the required zone, select the channel you require to transmit or receive on.

Channel Selector Knob

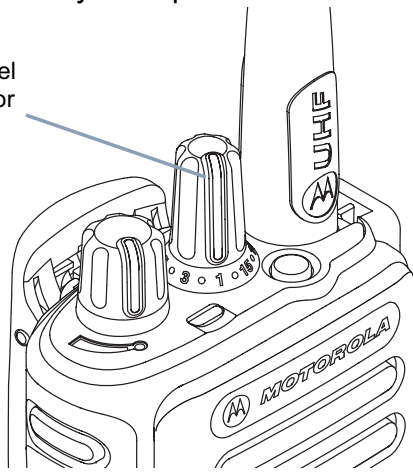

**Procedure:**

Turn the Channel Selector Knob to select the channel with the active group alias or ID.

---



## ■ Receiving and Responding to a Radio Call

Once the channel, subscriber ID, or group ID is set, you can proceed to receive and respond to calls.

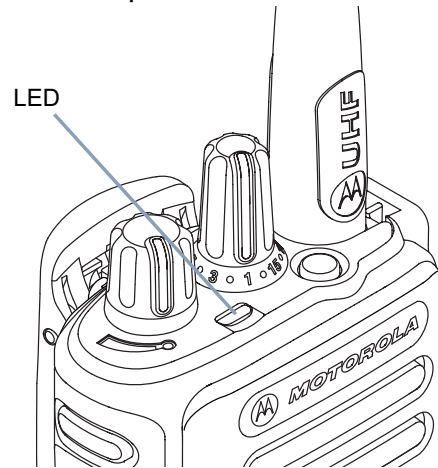

*The LED lights up solid green while the radio is transmitting and blinks when the radio is receiving.*

**NOTE:** The LED lights up solid green while the radio is transmitting and double blinks green when the radio is receiving a privacy-enabled call.

To unscramble a privacy-enabled call, your radio must have the same Privacy Key, OR the same Key Value and Key ID (programmed by your dealer) as the transmitting radio (the radio you are receiving

the call from).

See **Privacy** on page 33 for more information. 

### Receiving and Responding to a Group Call

To receive a call made to a group of users, your radio must be configured as part of that group.

#### Procedure:

- 1 The LED blinks green. Your radio unmutes and the incoming call sounds through the radio's speaker.

---

- 2 To respond, hold the radio vertically 1 to 2 inches (2.5 to 5.0 cm) from your mouth.

---

- 3  If the Channel Free Indication feature is enabled, you hear a short alert tone the moment the transmitting radio releases the **PTT** button, indicating the channel is free for you to respond.  
Press the **PTT** button to respond to the call.

**OR**

-  If the Voice Interrupt feature is enabled, press the **PTT** button to stop the current call from the transmitting radio and free the channel for you to talk/respond.

---

- 4 The LED lights up solid green.

---

- 5 Wait for the Talk Permit Tone to finish (if enabled) and speak clearly into the microphone.

**OR**

Wait for the **PTT** Sidetone to finish (if enabled) and speak clearly into the microphone.

- 6 Release the **PTT** button to listen.
- 7 If there is no voice activity for a predetermined period of time, the call ends.

See ***Making a Group Call*** on page 19 for details on making a Group Call.

### **Receiving and Responding to a Private Call**

A Private Call is a call from an individual radio to another individual radio.

**Procedure:**

When you receive a Private Call:

- 1 The LED blinks green. Your radio unmutes and the incoming call sounds through the radio's speaker.
- 2 To respond, hold the radio vertically 1 to 2 inches (2.5 to 5.0 cm) from your mouth.
- 3 If the Channel Free Indication feature is enabled, you hear a short alert tone the moment the transmitting radio releases the **PTT** button, indicating the channel is free for you to respond.

**OR**

If the Voice Interrupt feature is enabled, press the **PTT** button to stop the current call from the transmitting radio and free the channel for you to talk/respond.

- 4 Press the **PTT** button to respond to the call. The LED lights up solid green.
- 5 Wait for the Talk Permit Tone to finish (if enabled) and speak clearly into the microphone.
- 6 Release the **PTT** button to listen.
- 7 If there is no voice activity for a predetermined period of time, the call ends.
- 8 You hear a short tone.

See ***Making a Private Call*** on page 19 for details on making a Private Call.

### **Receiving and Responding to a Selective Call**

A Selective Call is a call from an individual radio to another individual radio. It is a Private Call on an analog system.

**Procedure:**

When you receive a Selective Call:

- 1 The LED blinks green. Your radio unmutes and the incoming call sounds through the radio's speaker.

- 2 To respond, hold the radio vertically 1 to 2 inches (2.5 to 5.0 cm) from your mouth.

---

- 3 If the Channel Free Indication feature is enabled, you hear a short alert tone the moment the transmitting radio releases the **PTT** button, indicating the channel is free for you to respond.

---

- 4 Press the **PTT** button to respond to the call. The LED lights up solid green.

---

- 5 Wait for the Talk Permit Tone to finish (if enabled) and speak clearly into the microphone.

---

- 6 Release the **PTT** button to listen.

---

- 7 If there is no voice activity for a predetermined period of time, the call ends.

---

- 8 You hear a short tone.

---

See **Making a Selective Call** on page 20 for details on making a Selective Call.

### Receiving an All Call

An All Call is a call from an individual radio to every radio on the channel. It is used to make important announcements requiring the user's full attention.

### Procedure:

When you receive an All Call:

- 1 A tone sounds and the LED blinks green. Your radio unmutes and the incoming call sounds through the radio's speaker.

---

- 2 An All Call does not wait for a predetermined period of time before ending.
  -  If the Channel Free Indication feature is enabled, you hear a short alert tone the moment the transmitting radio releases the **PTT** button, indicating the channel is now available for use.

---

*You cannot respond to an All Call.*

**NOTE:** The radio stops receiving the All Call if you switch to a different channel while receiving the call. During an All Call, you are **not** able to use any programmed button functions until the call ends.

### Receiving and Responding to a Phone Call

#### Phone Call as a Private Call or Group Call

### Procedure:

When you receive a Phone Call as a Private Call or Group Call:

- 1 The LED blinks green. Your radio unmutes and the incoming call sounds through the radio's speaker.

---

- 2 To respond, hold the radio vertically 1 to 2 inches (2.5 to 5.0 cm) from your mouth.
- 3 Press the **PTT** button to talk and release it to listen.
- 4 Press  to end the call.
- 5 You hear a short tone.

*If Phone Call capability is not enabled in your radio, your radio mutes the call.*

### **Phone Call as an All Call**

#### **Procedure:**

When you receive a Phone Call as an All Call:

- 1 The LED blinks green. Your radio unmutes and the incoming call sounds through the radio's speaker.
- 2 Press the **PTT** button to talk and release it to listen.

*If Phone Call capability is not enabled in your radio, your radio mutes the call.*

When you receive a Phone Call as an All Call, you can respond to the call or end the call, only if an All Call type is assigned to the channel.

## ■ Making a Radio Call

After selecting your channel, you can select a subscriber alias or ID, or group alias or ID by using:

- The Channel Selector Knob
- A programmed **One Touch Access** button 

**NOTE:** Your radio must have the Privacy feature enabled on the channel to send a privacy-enabled transmission. Only target radios with the same Privacy Key OR the same Key Value and Key ID as your radio are able to unscramble the transmission.

See **Privacy** on page 33 for more information. 

The One Touch Access feature allows you to make a Group or Private Call to a predefined ID easily. This feature can be assigned to a short or long programmable button press. You can **ONLY** have one ID assigned to a **One Touch Access** button. Your radio can have multiple **One Touch Access** buttons programmed.

## Making a Call with the Channel Selector Knob

### Making a Group Call

To make a call to a group of users, your radio must be configured as part of that group.

#### Procedure:

- 1 Select the channel with the active group alias or ID. See **Selecting a Channel** on page 14.  
**OR**  
Press the programmed **One Touch Access** button.

---

- 2 Hold the radio vertically 1 to 2 inches (2.5 to 5.0 cm) from your mouth.

---

- 3 Press the **PTT** button to make the call. The LED lights up solid green.

---

- 4 Wait for the Talk Permit Tone to finish (if enabled) and speak clearly into the microphone.  
**OR**  
 Wait for the **PTT Sidetone** to finish (if enabled) and speak clearly into the microphone.

---

- 5 Release the **PTT** button to listen. When the target radio responds, the LED blinks green.

---

- 6 If the Channel Free Indication feature is enabled, you hear a short alert tone the moment the target radio releases the **PTT** button, indicating the channel is free for you to respond.

Press the **PTT** button to respond. 

#### **OR**

If there is no voice activity for a predetermined period of time, the call ends.

### Making a Private Call

While you can receive and/or respond to a Private Call initiated by an authorized individual radio, your radio must be programmed for you to initiate a Private Call.

There are two types of Private Calls. The first type, where a radio presence check is performed prior to setting up the call, while the other sets up the call immediately.

Only **one** of these call types can be programmed to your radio by your dealer.

You hear a negative indicator tone, when you make a Private Call via the **One Touch Access** button or the Channel Selector Knob, if this feature is not enabled.

Use the Quick Text Message or Call Alert features to contact an individual radio. See **Text Messaging Features** on page 32 or **Call Alert Operation** on page 27 for more information.

**Procedure:**

- 1 Select the channel with the active group alias or ID. See **Selecting a Channel** on page 14.  
**OR**  
Press the programmed **One Touch Access** button.
- 2 Hold the radio vertically 1 to 2 inches (2.5 to 5.0 cm) from your mouth.
- 3 Press the **PTT** button to make the call. The LED lights up solid green.
- 4 Wait for the Talk Permit Tone to finish (if enabled) and speak clearly into the microphone.
- 5 Release the **PTT** button to listen. When the target radio responds, the LED blinks green.
- 6 If the Channel Free Indication feature is enabled, you hear a short alert tone the moment the target radio releases the **PTT** button, indicating the channel is free for you to respond. Press the **PTT** button to respond.  
**OR**  
If there is no voice activity for a predetermined period of time, the call ends.
- 7 You hear a short tone.

 **Making a Selective Call**

Just like a Private Call, while you can receive and/or respond to a Selective Call initiated by an authorized individual radio, your radio must be programmed for you to initiate a Selective Call.

**Procedure:**

- 1 Select the channel with the active group alias or ID. See **Selecting a Channel** on page 14.
- 2 Hold the radio vertically 1 to 2 inches (2.5 to 5.0 cm) from your mouth.
- 3 Press the **PTT** button to make the call. The LED lights up solid green.
- 4 Wait for the Talk Permit Tone to finish (if enabled) and speak clearly into the microphone.
- 5 Release the **PTT** button to listen. When the target radio responds, the LED blinks green.
- 6 If the Channel Free Indication feature is enabled, you hear a short alert tone the moment the target radio releases the **PTT** button, indicating the channel is free for you to respond. Press the **PTT** button to respond.  
**OR**  
If there is no voice activity for a predetermined period of time, the call ends.
- 7 You hear a short tone.

## Making an All Call

This feature allows you to transmit to all users on the channel. Your radio must be programmed to allow you to use this feature.

### Procedure:

- 1 Select the channel with the active group alias or ID. See [Selecting a Channel](#) on page 14.
- 2 Hold the radio vertically 1 to 2 inches (2.5 to 5.0 cm) from your mouth.
- 3 Press the **PTT** button to make the call. The LED lights up solid green.
- 4 Wait for the Talk Permit Tone to finish (if enabled) and speak clearly into the microphone.  
**OR**  
 Wait for the **PTT** Sidetone to finish (if enabled) and speak clearly into the microphone.

*Users on the channel cannot respond to an All Call.*

## Making a Phone Call

**NOTE:** When you attempt to make or end a Phone Call without the access and deaccess codes preconfigured, the attempt fails and a negative indicator tone sounds.

### Procedure:

- 1 Press the programmed **One Touch Access** button to make a Phone Call to the predefined ID.  
If the entry for the **One Touch Access** button is empty, a negative indicator tone sounds.
- 2 If successful:  
The DTMF tone sounds. You hear the dialing tone of the telephone user.  
**OR**  
If unsuccessful:  
A negative indicator tone sounds and the Phone Call attempt fails. Repeat Step 1.
- 3 Press the **PTT** button to talk and release it to listen.
- 4 Press the programmed **Phone Exit** button to end the call and a DTMF tone sounds.

- 5 If successful:  
A tone sounds and your radio exits the Phone Call.  
**OR**  
If unsuccessful:  
A negative indicator tone sounds and your radio returns to the Phone Call. Repeat Step 4 or wait for the telephone user to end the call.
- 

*For a Phone Call, you hear a short tone when making the call fails.*

## ■ Stopping a Radio Call

---

This feature allows you to stop an ongoing Group or Private Call to free the channel for transmission. For example, when a radio experiences a “stuck microphone” condition where the **PTT** button is inadvertently pressed by the user.

Your radio must be programmed to allow you to use this feature.

### **Procedure:**

While on the required channel:

- 1 Press the programmed **Transmit Interrupt Remote Dekey** button.
  - 2 Wait for acknowledgment.
  - 3 The radio sounds a positive indicator tone, indicating that the channel is now free.
- 

### **OR**

The radio sounds a negative indicator tone, indicating that the radio is unable to free the channel.

---

*Your radio sounds a negative indicator tone until you release the **PTT** button, if it is transmitting an interruptible call that is stopped via this feature. On an interrupted radio with a display, the display shows *Call Interrupted*.*

## ■ Talkaround

---

You can continue to communicate when your repeater is not operating, or when your radio is out of the repeater’s range but within talking range of other radios. This is called “talkaround”.

**NOTE:** This feature is not applicable in Capacity Plus and Linked Capacity Plus.

### **Procedure:**

- 1 Press the programmed **Repeater/Talkaround** button.
  - 2 You hear a positive indicator tone, indicating the radio is in Talkaround mode.  
**OR**  
You hear a negative indicator tone, indicating the radio is in Repeater mode.
- 

*The Talkaround setting is retained even after powering down.*



## ■ Monitoring Features

---

### Monitoring a Channel

Use the Monitor feature to make sure a channel is free before transmitting.

**NOTE:** This feature is not applicable in Capacity Plus and Linked Capacity Plus.

#### **Procedure:**

- 1 Press and hold the programmed **Monitor** button and listen for activity.
- 2 You hear radio activity or total silence, depending on how your radio is programmed.
- 3 When you hear “white noise” (that is, the channel is free), press the **PTT** button to talk and release it to listen. The LED lights up solid yellow.

### Permanent Monitor

Use the Permanent Monitor feature to continuously monitor a selected channel for activity.

**NOTE:** This feature is not applicable in Capacity Plus and Linked Capacity Plus.

#### **Procedure:**

- 1 Press the programmed **Permanent Monitor** button.
- 2 Radio sounds alert tone, and the LED lights up solid yellow.
- 3 Press the programmed **Permanent Monitor** button to remove the radio from permanent monitor mode.
- 4 Radio sounds an alert tone and the LED turns off.

## Advanced Features

Use this navigation guide to learn more about advanced features available with your radio:

Scan Lists . . . . .	page 24
Scan . . . . .	page 25
Call Indicator Settings . . . . .	page 27
Call Alert Operation . . . . .	page 27
Emergency Operation . . . . .	page 28
Text Messaging Features . . . . .	page 32
Privacy . . . . .	page 33
Multi-Site Controls . . . . .	page 37
Lone Worker . . . . .	page 35
Password Lock Features . . . . .	page 35
Auto-Range Transponder System (ARTS) . . . . .	page 36
Over-the-Air Programming (OTAP) . . . . .	page 37
Utilities . . . . .	page 37

## Scan Lists

Scan lists are created and assigned to individual channels/groups. Your radio scans for voice activity by cycling through the channel/group sequence specified in the scan list for the current channel.

Your radio supports up to 250 scan lists, with a maximum of 16 members in a list. Each scan list shall support a mixture of both analog and digital entries.

**NOTE:** This feature is not applicable in Capacity Plus and Linked Capacity Plus.

## ■ Scan

---

When you start a scan, your radio cycles through the programmed scan list for the current channel looking for voice activity.

The LED blinks yellow.

During a dual mode scan, if you are on a digital channel, and your radio locks onto an analog channel, it automatically switches from digital mode to analog mode for the duration of the call. This is also true for the reverse.

There are two types of scans:

- **Main Channel Scan (Manual):** Your radio scans all the channels/groups in your scan list. On entering scan, your radio may – depending on the settings – automatically start on the last scanned “active” channel/group or on the channel where scan was initiated.
- **Auto Scan (Automatic):** Your radio automatically starts scanning when you select a channel/group that has Auto Scan enabled.

**NOTE:** This feature is not applicable in Capacity Plus and Linked Capacity Plus.

## 📄 Starting and Stopping Scan

**Procedure:**

- 1 Press the programmed **Scan** button.  
**OR**  
Use the Channel Selector Knob to select a channel with Auto Scan enabled.
- 
- 2 When Scan is enabled, the LED blinks yellow and you hear a positive indicator tone.  
**OR**  
When Scan is disabled, the LED turns off and you hear a negative indicator tone.
- 

## 📄 Responding to a Transmission During a Scan

During scanning, your radio stops on a channel/group where activity is detected. The radio stays on that channel for a programmed time period known as “hang time”.

**Procedure:**

- 1 Hold the radio vertically 1 to 2 inches (2.5 to 5.0 cm) from your mouth.  
 If the Channel Free Indication feature is enabled, you hear a short alert tone the moment the transmitting radio releases the **PTT** button, indicating the channel is free for you to respond.
-

- 2 Press the **PTT** button during hang time. The LED lights up solid green.
- 3 Wait for the Talk Permit Tone to finish (if enabled) and speak clearly into the microphone.  
**OR**  
 Wait for the **PTT** Sidetone to finish (if enabled) and speak clearly into the microphone.
- 4 Release the **PTT** button to listen.
- 5 If you do not respond within the hang time, the radio returns to scanning other channels/groups.

### Deleting a Nuisance Channel

If a channel continually generates unwanted calls or noise (termed a “nuisance” channel), you can temporarily remove the unwanted channel from the scan list.

This capability does not apply to the channel designated as the Selected Channel.

#### **Procedure:**

- 1 When your radio “locks on to” an unwanted or nuisance channel, press the programmed **Nuisance Channel Delete** button until you hear a tone.
- 2 Release the **Nuisance Channel Delete** button. The nuisance channel is deleted.

### Restoring a Nuisance Channel

#### **Procedure:**

To restore the deleted nuisance channel, do **one** of the following:

- Turn the radio off and power it on again, **OR**
- Stop and restart a scan via the programmed **Scan** button, **OR**
- Change the channel via the Channel Selector Knob.

### Vote Scan

Vote Scan provides you with wide area coverage in areas where there are multiple base stations transmitting identical information on different analog channels.

Your radio scans analog channels of multiple base stations and performs a voting process to select the strongest received signal. Once that is established, your radio unmutes to transmissions from that base station.

The LED blinks yellow during the Vote Scan operation.

*To respond to a transmission during a Vote Scan, follow the same procedures as **Responding to a Transmission During a Scan** on page 25.*

## ■ Call Indicator Settings

---

You can turn on or off the ringing tones for a received Private Call (see *Turning Radio Tones/Alerts On or Off* on page 38).

### Escalating Alarm Tone Volume

Your radio can be programmed by your dealer to continually alert you when a radio call remains unanswered. This is done by automatically increasing the alarm tone volume over time.

This feature is known as Escalart.

## ■ Call Alert Operation

---

Call Alert paging enables you to alert a specific radio user to call you back when they are able to do so. This feature is accessible via a programmed **One Touch Access** button.

### Receiving and Responding to a Call Alert

#### Procedure:

When you receive a Call Alert page:

- 1 You hear a repetitive tone. The LED blinks yellow.
  - 2 Press the **PTT** button within four (4) seconds of receiving a Call Alert page to respond to the Private Call.
- 

### Making a Call Alert with the One Touch Access Button

#### Procedure:

- 1 Press the programmed **One Touch Access** button to make a Call Alert to the predefined ID.
  - 2 The LED lights up solid green when your radio is sending the Call Alert.
  - 3 If the Call Alert acknowledgement is received, two chirps sound.  
**OR**  
If the Call Alert acknowledgement is not received, a low-pitched tone sounds.
-

## ■ Emergency Operation

---

An Emergency Alarm is used to indicate a critical situation. You are able to initiate an Emergency at any time, in any state, even when there is activity on the current channel.

Your dealer can set the duration of a button press for the programmed **Emergency** button, except for long press, which is similar with all other buttons:

- Short press – Between 0.05 seconds and 0.75 seconds
- Long press – Between 1.00 second and 3.75 seconds

The **Emergency** button is assigned with the Emergency On/Off feature. Check with your dealer for the assigned operation of the **Emergency** button.

*If short press the **Emergency** button is assigned to turn on the Emergency mode, then long press the **Emergency** button is assigned to exit the Emergency mode.*

*If long press the **Emergency** button is assigned to turn on the Emergency mode, then short press the **Emergency** button is assigned to exit the Emergency mode.*

Your radio supports **three** Emergency Alarms:

- Emergency Alarm
- Emergency Alarm with Call
- Emergency Alarm with Voice to Follow 

In addition, each alarm has the following types:

- **Regular** – Radio transmits an alarm signal and shows audio and/or visual indicators.
- **Silent** – Radio transmits an alarm signal without any audio or visual indicators. Radio receives calls without any sound through the radio's speaker, until you press the **PTT** button to initiate the call.
- **Silent with Voice** – Radio transmits an alarm signal without any audio or visual indicators, but allow incoming calls to sound through the radio's speaker.

Only **one** of the Emergency Alarms above can be assigned to the programmed **Emergency** button.

## Sending an Emergency Alarm

This feature allows you to send an Emergency Alarm, a non-voice signal, which triggers an alert indication on a group of radios.

### Procedure:

- 1 Press the programmed **Emergency On** button.
- 2 The LED lights up solid green.
- 3 When an Emergency Alarm acknowledgment is received, the Emergency tone sounds. The LED blinks green.  
**OR**  
If your radio does not receive an Emergency Alarm acknowledgement, and after all retries have been exhausted, a low-pitched tone sounds.
- 4 Radio exits the Emergency Alarm mode.

*If your radio is set to Silent, it does not display any audio or visual indicators during Emergency mode.*

## Sending an Emergency Alarm with Call

This feature allows you to send an Emergency Alarm to a group of radios. Upon acknowledgement by a radio within the group, the group of radios can communicate over a programmed Emergency channel.

### Procedure:

- 1 Press the programmed **Emergency On** button.
- 2 The LED lights up solid green.
- 3 When an Emergency Alarm acknowledgment is received, the Emergency tone sounds. The LED blinks green.
- 4 Hold the radio vertically 1 to 2 inches (2.5 to 5.0 cm) from your mouth.
- 5 Press the **PTT** button to make the call. The LED lights up solid green.
- 6 Wait for the Talk Permit Tone to finish (if enabled) and speak clearly into the microphone.  
**OR**  
 Wait for the **PTT** Sidetone to finish (if enabled) and speak clearly into the microphone.
- 7 Release the **PTT** button to listen.

- 8 When the channel is free for you to respond, a short alert tone sounds (  if the Channel Free Indication feature is enabled). Press the **PTT** button to respond.

**OR**

Once your call ends, press **Emergency Off** button to exit the Emergency mode.

---

*If your radio is set to Silent, it does not display any audio or visual indicators during Emergency mode, or allow any received calls to sound through the radio's speaker, until you press the **PTT** button to initiate the call.*

*If your radio is set to Silent with Voice, it does not display any audio or visual indicators during Emergency mode, but allow incoming calls to sound through the radio's speaker. The indicators only appear once you press the **PTT** button to initiate, or respond to, the call.*

## **Sending an Emergency Alarm with Voice to Follow**

This feature allows you to send an Emergency Alarm to a group of radios. Your radio's microphone is automatically activated, allowing you to communicate with the group of radios without pressing the **PTT** button.

This activated microphone state is also known as "hot mic".

If your radio has Emergency Cycle Mode enabled, repetitions of hot mic and receiving period are made for a programmed duration.

**NOTE:** During Emergency Cycle Mode, received calls sound through the radio's speaker.

If you press the **PTT** button during the programmed receiving period, you will hear a prohibit tone, indicating that you should release the **PTT** button. The radio ignores the **PTT** press and remains in Emergency mode.

**NOTE:** If you press the **PTT** button during hot mic, and continue to press it after the hot mic duration expires, the radio continues to transmit until you release the **PTT** button.

### **Procedure:**

- 1 Press the programmed **Emergency On** button.
  - 2 The LED lights up solid green.
-



- 3** Once a tone sounds, speak clearly into the microphone. When hot mic has been enabled, the radio automatically transmits without a **PTT** press until the hot mic duration expires.

While transmitting, the LED lights up solid green.

---

- 4** The radio automatically stops transmitting when: Once the cycling duration between hot mic and receiving calls expires, if Emergency Cycle Mode is enabled.

**OR**

Once the hot mic duration expires, if Emergency Cycle Mode is disabled.

---

- 5** To transmit again, press the **PTT** button.

**OR**

Press the programmed **Emergency Off** button to exit the Emergency mode.

---

- 6** Press **Emergency Off** button to exit the Emergency mode.
- 

*If your radio is set to Silent, it does not display any audio or visual indicators during Emergency mode, or allow any received calls to sound through the radio's speaker, until the programmed hot mic transmission period is over, and you press the **PTT** button.*

*If your radio is set to Silent with Voice, it does not display any audio or visual indicators during Emergency mode when you are making the call with hot mic, but allow sound through the radio's speaker when the target radio responds after the programmed hot mic transmission period is over. The indicators only appear when you press the **PTT** button.*

**NOTE:** If the Emergency Alarm request fails, the radio does not retry to send the request, and enters the hot mic state directly.

### Reinitiating an Emergency Mode

**NOTE:** This feature is only applicable to the radio sending the Emergency Alarm.

There are two instances where this can happen:

- You change the channel while the radio is in Emergency mode. This exits the Emergency mode. If Emergency Alarm is enabled on this new channel, the radio reinitiates Emergency.
- You press the programmed **Emergency On** button during an Emergency initiation/transmission state. This causes the radio to exit this state, and to reinitiate Emergency.

## Exiting an Emergency Mode

**NOTE:** This feature is only applicable to the radio sending the Emergency Alarm.

Your radio exits Emergency mode when **one** of the following occurs:

- Emergency Alarm acknowledgement is received (for **Emergency Alarm** only), **OR**
-  An Emergency Exit Telegram is received, **OR**
- All retries to send the alarm have been exhausted, **OR**
- The **Emergency Off** button is pressed, **OR**
- Turn the radio off and then power it on again if your radio has been programmed to remain on the Emergency Revert channel even after acknowledgement is received.

**NOTE:** If your radio is powered off, it exits the Emergency mode. The radio does not reinitiate the Emergency mode automatically when it is turned on again.

## ■ Text Messaging Features

---

### Sending a Quick Text Message

You can send Quick Text messages, programmed by your dealer, via the programmable button.

#### **Procedure:**

- 1** Press the programmed **One Touch Access** button to send a predefined Quick Text message to a predefined ID.
  - 2** The LED lights up solid green.
  - 3** Two chirps indicate that the message is sent successfully.  
**OR**  
A low-pitched tone indicates that the message cannot be sent.
-

## ■ Privacy

---

If enabled, this feature helps to prevent eavesdropping by unauthorized users on a channel by the use of a software-based scrambling solution. The signaling and user identification portions of a transmission are not scrambled.

Your radio must have privacy enabled on the channel to send a privacy-enabled transmission, although this is not a necessary requirement for receiving a transmission. While on a privacy-enabled channel, the radio is still able to receive clear (unscrambled) transmissions.

Your radio supports two types of privacy:

- Basic Privacy
- Enhanced Privacy

Only **ONE** of the privacy types above can be assigned to the radio.

To unscramble a privacy-enabled call or data transmission, your radio must be programmed to have the same Privacy Key (for Basic Privacy), OR the same Key Value and Key ID (for Enhanced Privacy) as the transmitting radio.

If your radio receives a scrambled call that is of a different Privacy Key, OR a different Key Value and Key ID, you will either hear a garbled transmission (Basic Privacy) or nothing at all (Enhanced Privacy).

The LED lights up solid green while the radio is transmitting and blinks green rapidly when the radio is receiving an ongoing privacy-enabled transmission.

**NOTE:** Some radio models may not offer this Privacy feature. Check with your dealer or system administrator for more information.

**Procedure:**

Press the programmed **Privacy** button to toggle privacy on or off.

## ■ Multi-Site Controls

These features are applicable when your current radio channel is part of an IP Site Connect or Linked Capacity Plus configuration.

**NOTE:** See **IP Site Connect** on page 10 and **Linked Capacity Plus** on page 11 for more details about these configurations.

### Starting an Automatic Site Search

**NOTE:** The radio **only** scans for a new site if the current signal is weak or when the radio is unable to detect any signal from the current site. If the RSSI value is strong, the radio remains on the current site.

#### Procedure:

- 1 Press the programmed **Site Lock On/Off** button.
- 2 A tone sounds.
- 3 The LED blinks yellow rapidly when the radio is actively searching for a new site, and turns off once the radio locks on to a site.

*The radio also performs an automatic site search (site is unlocked) during a **PTT** button press or data transmission if the current channel, a multi-site channel with an attached roam list, is out of range.*

### Stopping an Automatic Site Search

When the radio is actively searching for a new site:

#### Procedure:

- 1 Press the programmed **Site Lock On/Off** button.
- 2 A tone sounds and the LED turns off.

### Starting a Manual Site Search

#### Procedure:

- 1 Press the programmed **Manual Site Roam** button.
- 2 A tone sounds and the LED blinks green.
- 3 You hear a positive indicator tone and the LED turns off, indicating the radio is locked on to a site.  
**OR**  
You hear a negative indicator tone and the LED turns off, indicating the radio is unable to lock on to a site.

## ■ Lone Worker

---

This feature prompts an emergency to be raised if there is no user activity, such as any radio button press or activation of the channel selector, for a predefined time.

Following no user activity for a programmed duration, the radio pre-warns the user via an audio indicator once the inactivity timer expires.

If there is still no acknowledgment by the user before the predefined reminder timer expires, the radio initiates an Emergency Alarm.

Only **one** of the following Emergency Alarms is assigned to this feature:

- Emergency Alarm
- Emergency Alarm with Call
- Emergency Alarm with Voice to Follow 

The radio remains in the emergency state allowing voice messages to proceed until action is taken. See **Emergency Operation** on page 28 on ways to exit Emergency.

**NOTE:** This feature is limited to radios with this function enabled. Check with your dealer or system administrator for more information.

## ■ Password Lock Features

---

If enabled, this feature allows you to access your radio via password upon powering up. Use the Channel Selector Knob and the three Side Buttons to enter password (see **Radio Controls** of page 6):

- Channel Selector Knob positions 1 to 9 represent digits 1 to 9, and position 10 represents digit 0.
- Side Buttons 1 to 3 represent digits 1 to 3.

### Accessing the Radio from Password

#### **Procedure:**

Power up the radio.

- 1** You hear a continuous tone.

---

- 2** Use the Channel Selector Knob to enter the first digit of the password.

---

- 3** Press Side Button 1, 2 or 3 to enter each digit of the remaining three digits of the password. You hear a positive indicator tone for each Side Button press. When the second digit of the password is entered, your radio ignores any Channel Selector Knob position change.

---

- 4 When the last digit of the four-digit password is entered, your radio automatically checks the validity of the password. If the password is correct:  
Your radio proceeds to power up. See **Powering Up the Radio** on page 5.

**OR**

If the password is incorrect:

You hear a continuous tone. Repeat Steps 1 to 3.

**OR**

After the third incorrect password, your radio enters into locked state. A tone sounds and the LED double blinks yellow.

---

*Your radio enters into locked state for 15 minutes, and responds to inputs from **On/Off/Volume Control Knob**.*

**NOTE:** The radio is unable to receive any call, including emergency calls, in locked state.

### **Unlocking the Radio from Locked State**

**Procedure:**

Wait for 15 minutes. Repeat Steps 1 to 4 in **Accessing the Radio from Password** on page 35.

**OR**

Power up the radio, if you have powered down the radio during locked state:

- 1 A tone sounds and the LED double blinks yellow.

- 2 Wait for 15 minutes. Repeat Steps 1 to 4 in **Accessing the Radio from Password** on page 35.

---

*Your radio restarts the 15 minutes timer for locked state when you power up.*

## ■ **Auto-Range Transponder System (ARTS)**

---

ARTS is an analog-only feature designed to inform you when your radio is out-of-range of other ARTS-equipped radios.

ARTS-equipped radios transmit or receive signals periodically to confirm that they are within range of each other. Your dealer can program your radio to transmit or receive the ARTS signal.

Your radio provides indications of states as follows:

- **First-Time Alert** – A tone sounds.
- **ARTS-in-Range Alert** – A tone sounds, if programmed.
- **ARTS-Out-of-Range Alert** – A tone sounds, and the LED rapidly blinks red.

## ■ Over-the-Air Programming (OTAP)

Your radio can be updated by your dealer remotely, via OTAP, without needing to be physically connected. Additionally, some settings can also be configured via OTAP.

While undergoing OTAP, the LED blinks green.

**NOTE:** When the radio is receiving high volume data, the channel is busy. A PTT button press at this time causes a negative tone to sound.

Once the programming is complete, a tone sounds, and your radio restarts (powers off and on again).

## ■ Utilities

### Setting the Squelch Level

You can adjust your radio's squelch level to filter out unwanted calls with low signal strength or channels that have a higher than normal background noise.

**Settings:** **Normal** is the default. **Tight** filters out (unwanted) calls and/or background noise. However, calls from remote locations may also be filtered out.

### Procedure:

- 1 Press the programmed **Squelch** button.
- 2 You hear a positive indicator tone, indicating the radio is operating in tight squelch.  
**OR**  
You hear a negative indicator tone, indicating the radio is operating in normal squelch.

### Setting the Power Level

You can toggle your radio's power setting between high or low for each channel.

**Settings:** **High** enables communication with radios located at a considerable distance from you. **Low** enables communication with radios in closer proximity.

### Procedure:

- 1 Press the programmed **Power Level** button.
- 2 You hear a positive indicator tone, indicating the radio is transmitting at low power.  
**OR**  
You hear a negative indicator tone, indicating the radio is transmitting at high power.

### Turning the Option Board Feature(s) On or Off

A channel can support up to 6 option board features. Refer to your dealer or system administrator for more information.

#### **Procedure:**

Press the programmed **Option Board Feature** button to toggle the feature on or off.

### Turning the Voice Operating Transmission (VOX) Feature On or Off

This feature allows you to initiate a hands-free voice activated call on a programmed channel. The radio automatically transmits, for a programmed period, whenever the microphone on the VOX-capable accessory detects voice.

Pressing the **PTT** button during radio operation disables VOX. To re-enable VOX, do **one** of the following:

- Turn the radio off and power it on again, **OR**
- Change the channel via the Channel Selector Knob, **OR**
- Follow the procedure below.

**NOTE:** Turning this feature on or off is limited to radios with this function enabled. Check with your dealer or system administrator for more information.

#### **Procedure:**

Press the programmed **VOX** button to toggle the feature on or off.

*If the Talk Permit Tone feature is enabled, use a trigger word to initiate the call. Wait for the Talk Permit Tone to finish before speaking clearly into the microphone.*

### Turning Radio Tones/Alerts On or Off

You can enable and disable all radio tones and alerts (except for the incoming Emergency alert tone) if needed.

#### **Procedure:**

- 1** Press the programmed **All Tones/Alerts** button.

---
- 2** You hear a positive indicator tone, indicating all tones and alerts are on.  
**OR**  
You hear a negative indicator tone, indicating all tones and alerts are off.

---



## **Checking the Battery Strength**

You can check how much battery power you have left.

**Settings:** The LED Indicator in solid yellow indicates fair battery charge while solid green indicates full charge of the battery.

See also **LED Indicator** on page 12.

### **Procedure:**

Press the programmed **Battery Strength** button to view the battery strength via the LED Indicator.

## **Voice Announcement**

This feature enables the radio to audibly indicate the current Zone or Channel the user has just assigned, or programmable button press. This audio indicator can be customized per customer requirements. This is typically useful when the user is in a difficult condition to read the content shown on the display.

Your dealer can record Voice Announcement files in English, Spanish and Brazilian Portuguese.

Use the following features to toggle Voice Announcement on or off.

### **Procedure:**

Press the programmed **Voice Announcement** button.

## **Intelligent Audio**

Your radio automatically adjusts its audio volume to overcome current background noise in the environment, inclusive of both stationary and non-stationary noise sources. This feature is a Receive-only feature and does not affect Transmit audio.

Use the following features to toggle Intelligent Audio on or off.

### **Procedure:**

Press the programmed **Intelligent Audio** button to toggle the feature on or off.

## **GPS**

Global Positioning System (GPS) is a satellite navigation system that determines the radio's precise location.

### **Procedure:**

Press the programmed **GPS** button to toggle the feature on or off.

## Accessories

Your radio is compatible with the accessories listed in this chapter. Contact your dealer for details.

Antennas . . . . .	page 40
Batteries . . . . .	page 40
Carry Devices . . . . .	page 40
Chargers . . . . .	page 40
Headsets and Headset Accessories . . . . .	page 41
Remote Speaker Microphones . . . . .	page 41
Miscellaneous Accessories . . . . .	page 41

### ■ Antennas

- UHF, 403-470MHz, Whip Antenna EX (PMAE4085\_)
- UHF, 403-433MHz, GPS Folded Monopole Antenna EX (PMAE4081\_)
- UHF, 430-470MHz, GPS Folded Monopole Antenna EX (PMAE4082\_)
- UHF, 403-433MHz, GPS Stubby Antenna EX (PMAE4083\_)
- UHF, 430-470MHz, GPS Stubby Antenna EX (PMAE4084\_)
- VHF, 136-174MHz, Double Helical Antenna EX (PMAD4132\_)
- VHF, 136-147MHz, GPS Helical Antenna EX (PMAD4126)

- VHF, 147-160MHz, GPS Helical Antenna EX (PMAD4127\_)
- VHF, 160-174MHz, GPS Helical Antenna EX (PMAD4128\_)
- VHF, 136-147MHz, GPS Stubby Antenna EX (PMAD4129\_)
- VHF, 147-160MHz, GPS Stubby Antenna EX (PMAD4130\_)
- VHF, 160-174MHz, GPS Stubby Antenna EX (PMAD4131\_)

### ■ Batteries

- MOTOTRBO CSA/IECEX/ATEX IMPRES Li-Ion, 2075mA (NNTN8359\_)

### ■ Carry Devices

- 2.5-Inch Replacement Swivel Belt Loop (PMLN5610\_)
- Hard Leather Carry Case with 2.5-Inch Swivel Belt Loop for Non-Display Radio (PMLN6096\_)
- Soft Leather Carry Case with 2.5-Inch Swivel Belt Loop for Non-Display Radio (PMLN6098\_)
- Belt Clip for 2.5-Inch Belt Width (PMLN6086\_)

### ■ Chargers

- IMPRES Multi-Unit Charger with Display (WPLN4218\_)
- IMPRES Single-Unit Charger (WPLN4226\_)

## ■ Headsets and Headset Accessories

---

- IS Approved Standard Headset with Head Band (PMLN6087\_)
- IS Approved Standard Headset with Helmet Attachment (PMLN6092\_)
- IS Approved Twin Cup Headset with Helmet Attachment (PMLN6333\_)
- IS Approved Level Dependent Headset with Head Band (PMLN6090\_)
- IS Approved Level Dependent Headset with Helmet Attachment (PMLN6089\_)
- IS Approved MOTOTRBO Adapter, 4-pole Nexus (PMLN6368\_)

## ■ Remote Speaker Microphones

---

- IMPRES ATEX CSA Remote Speaker Microphone (PMMN4067\_)

## ■ Miscellaneous Accessories

---

- Universal Connector Dust Cover for MOTOTRBO ATEX CSA (15012157001)
- ATEX Adapter with Molex Jack (PMLN6047\_)

## Batteries and Chargers Warranty

### The Workmanship Warranty

The workmanship warranty guarantees against defects in workmanship under normal use and service.

All MOTOTRBO Batteries	Two (2) Years
IMPRES Chargers (Single-Unit and Multi-Unit, Non-Display)	Two (2) Years
IMPRES Chargers (Multi-Unit with Display)	One (1) Year

### The Capacity Warranty

The capacity warranty guarantees 80% of the rated capacity for the warranty duration.

MOTOTRBO CSA/IECEX/ATEX Lithium-Ion IMPRES Batteries	18 Months
IMPRES Batteries, When Used Exclusively with IMPRES Chargers	18 Months

# Limited Warranty

## MOTOROLA COMMUNICATION PRODUCTS

### I. WHAT THIS WARRANTY COVERS AND FOR HOW LONG:

MOTOROLA SOLUTIONS, INC. (“MOTOROLA”) warrants the MOTOROLA manufactured Communication Products listed below (“Product”) against defects in material and workmanship under normal use and service for a period of time from the date of purchase as scheduled below:

DGP Series Digital Portable Radios	Three (3) Years
Product Accessories (Excluding Batteries and Chargers)	One (1) Year

MOTOROLA, at its option, will at no charge either repair the Product (with new or reconditioned parts), replace it (with a new or reconditioned Product), or refund the purchase price of the Product during the warranty period provided it is returned in accordance with the terms of this warranty. Replaced parts or boards are warranted for the balance of the original applicable warranty period. All replaced parts of Product shall become the property of MOTOROLA.

This express limited warranty is extended by MOTOROLA to the original end user purchaser only and is not assignable or transferable to any other party. This is the complete warranty for the Product manufactured by MOTOROLA. MOTOROLA assumes no

obligations or liability for additions or modifications to this warranty unless made in writing and signed by an officer of MOTOROLA.

Unless made in a separate agreement between MOTOROLA and the original end user purchaser, MOTOROLA does not warrant the installation, maintenance or service of the Product.

MOTOROLA cannot be responsible in any way for any ancillary equipment not furnished by MOTOROLA which is attached to or used in connection with the Product, or for operation of the Product with any ancillary equipment, and all such equipment is expressly excluded from this warranty. Because each system which may use the Product is unique, MOTOROLA disclaims liability for range, coverage, or operation of the system as a whole under this warranty.

### II. GENERAL PROVISIONS:

This warranty sets forth the full extent of MOTOROLA'S responsibilities regarding the Product. Repair, replacement or refund of the purchase price, at MOTOROLA's option, is the exclusive remedy. THIS WARRANTY IS GIVEN IN LIEU OF ALL OTHER EXPRESS WARRANTIES. IMPLIED WARRANTIES, INCLUDING WITHOUT LIMITATION, IMPLIED WARRANTIES OF MERCHANTABILITY AND FITNESS FOR A PARTICULAR PURPOSE, ARE LIMITED TO THE DURATION OF THIS LIMITED WARRANTY. IN NO EVENT SHALL MOTOROLA BE LIABLE FOR DAMAGES IN EXCESS OF THE PURCHASE PRICE OF THE PRODUCT, FOR ANY LOSS OF USE, LOSS OF TIME, INCONVENIENCE, COMMERCIAL LOSS, LOST PROFITS OR SAVINGS OR OTHER INCIDENTAL, SPECIAL OR CONSEQUENTIAL DAMAGES ARISING OUT OF THE USE OR

INABILITY TO USE SUCH PRODUCT, TO THE FULL EXTENT SUCH MAY BE DISCLAIMED BY LAW.

### III. STATE LAW RIGHTS:

SOME STATES DO NOT ALLOW THE EXCLUSION OR LIMITATION OF INCIDENTAL OR CONSEQUENTIAL DAMAGES OR LIMITATION ON HOW LONG AN IMPLIED WARRANTY LASTS, SO THE ABOVE LIMITATION OR EXCLUSIONS MAY NOT APPLY.

This warranty gives specific legal rights, and there may be other rights which may vary from state to state.

### IV. HOW TO GET WARRANTY SERVICE:

You must provide proof of purchase (bearing the date of purchase and Product item serial number) in order to receive warranty service and, also, deliver or send the Product item, transportation and insurance prepaid, to an authorized warranty service location. Warranty service will be provided by MOTOROLA through one of its authorized warranty service locations. If you first contact the company which sold you the Product (e.g., dealer or communication service provider), it can facilitate your obtaining warranty service.

### V. WHAT THIS WARRANTY DOES NOT COVER:

- A) Defects or damage resulting from use of the Product in other than its normal and customary manner.
- B) Defects or damage from misuse, accident, water, or neglect.
- C) Defects or damage from improper testing, operation, maintenance, installation, alteration, modification, or adjustment.

- D) Breakage or damage to antennas unless caused directly by defects in material workmanship.
- E) A Product subjected to unauthorized Product modifications, disassembles or repairs (including, without limitation, the addition to the Product of non-MOTOROLA supplied equipment) which adversely affect performance of the Product or interfere with MOTOROLA's normal warranty inspection and testing of the Product to verify any warranty claim.
- F) Product which has had the serial number removed or made illegible.
- G) Rechargeable batteries if:
  - (1) any of the seals on the battery enclosure of cells are broken or show evidence of tampering.
  - (2) the damage or defect is caused by charging or using the battery in equipment or service other than the Product for which it is specified.
- H) Freight costs to the repair depot.
- I) A Product which, due to illegal or unauthorized alteration of the software/firmware in the Product, does not function in accordance with MOTOROLA's published specifications or the FCC certification labeling in effect for the Product at the time the Product was initially distributed from MOTOROLA.
- J) Scratches or other cosmetic damage to Product surfaces that does not affect the operation of the Product.
- K) Normal and customary wear and tear.

### VI. PATENT AND SOFTWARE PROVISIONS:

MOTOROLA will defend, at its own expense, any suit brought against the end user purchaser to the extent that it is based on a

claim that the Product or parts infringe a United States patent, and MOTOROLA will pay those costs and damages finally awarded against the end user purchaser in any such suit which are attributable to any such claim, but such defense and payments are conditioned on the following:

- A) that MOTOROLA will be notified promptly in writing by such purchaser of any notice of such claim;
- B) that MOTOROLA will have sole control of the defense of such suit and all negotiations for its settlement or compromise; and
- C) should the Product or parts become, or in MOTOROLA's opinion be likely to become, the subject of a claim of infringement of a United States patent, that such purchaser will permit MOTOROLA, at its option and expense, either to procure for such purchaser the right to continue using the Product or parts or to replace or modify the same so that it becomes non-infringing or to grant such purchaser a credit for the Product or parts as depreciated and accept its return. The depreciation will be an equal amount per year over the lifetime of the Product or parts as established by MOTOROLA.

MOTOROLA will have no liability with respect to any claim of patent infringement which is based upon the combination of the Product or parts furnished hereunder with software, apparatus or devices not furnished by MOTOROLA, nor will MOTOROLA have any liability for the use of ancillary equipment or software not furnished by MOTOROLA which is attached to or used in connection with the Product. The foregoing states the entire liability of MOTOROLA with respect to infringement of patents by the Product or any parts thereof.

Laws in the United States and other countries preserve for MOTOROLA certain exclusive rights for copyrighted MOTOROLA

software such as the exclusive rights to reproduce in copies and distribute copies of such MOTOROLA software. MOTOROLA software may be used in only the Product in which the software was originally embodied and such software in such Product may not be replaced, copied, distributed, modified in any way, or used to produce any derivative thereof. No other use including, without limitation, alteration, modification, reproduction, distribution, or reverse engineering of such MOTOROLA software or exercise of rights in such MOTOROLA software is permitted. No license is granted by implication, estoppel or otherwise under MOTOROLA patent rights or copyrights.

## VII. GOVERNING LAW:

This Warranty is governed by the laws of the State of Illinois, U.S.A.

---

## Notes







**MOTOROLA**

Motorola Solutions, Inc.  
1303 East Algonquin Road  
Schaumburg, Illinois 60196 U.S.A.

MOTOROLA, MOTO, MOTOROLA SOLUTIONS and the Stylized M logo are trademarks or registered trademarks of Motorola Trademark Holdings, LLC and are used under license.

All other trademarks are the property of their respective owners.

© 2012 Motorola Solutions, Inc. All rights reserved.

November 2012.

[www.motorolasolutions.com/mototrbo](http://www.motorolasolutions.com/mototrbo)



**68009587001-A**